

NIMBLES HEATSINKS

HS K1

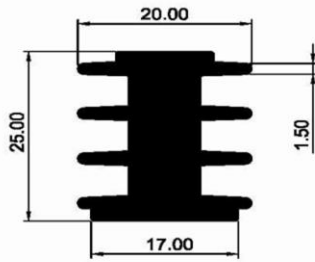

HS K2

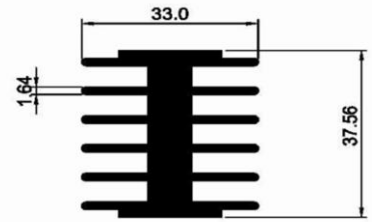

HS K3

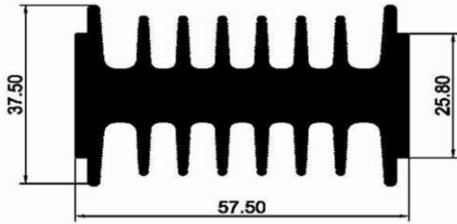

HS K4

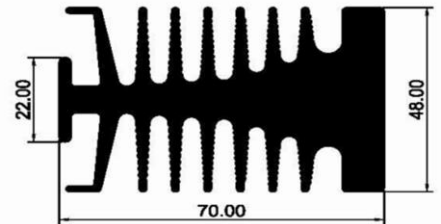

HS D30

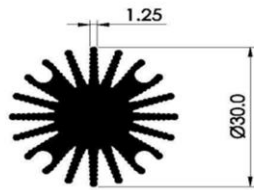

HS 1510

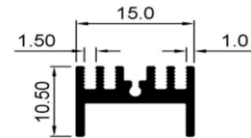

HS 2316

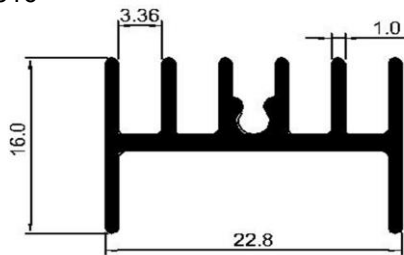

HS 1612

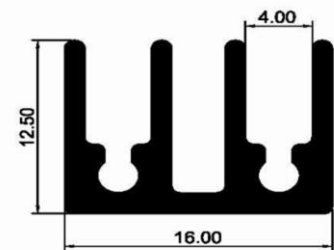

HS 3512

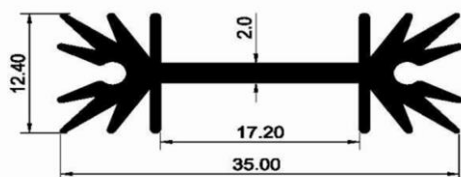

HS 4312



NIMBLES HEATSINKS

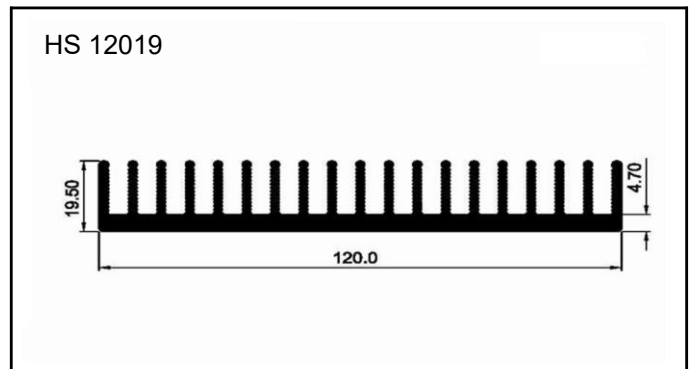
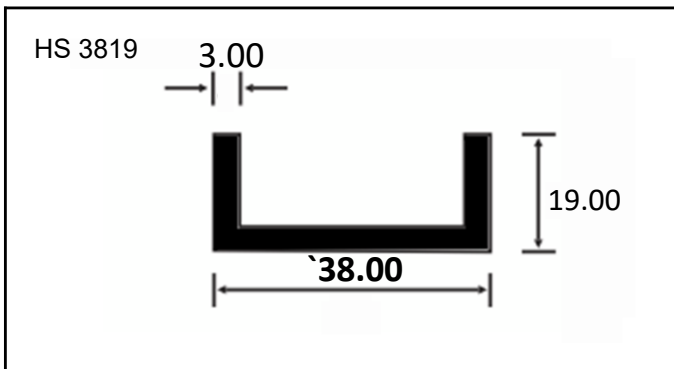
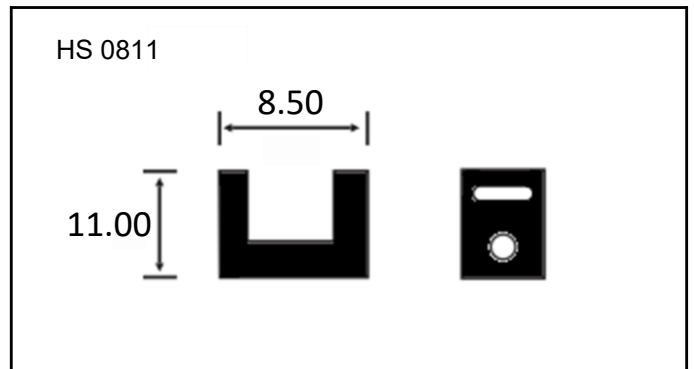
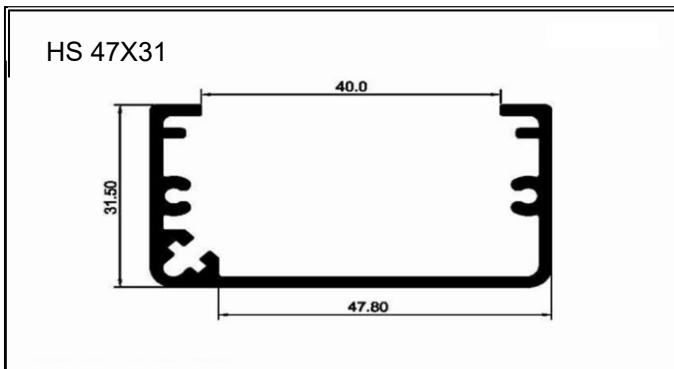
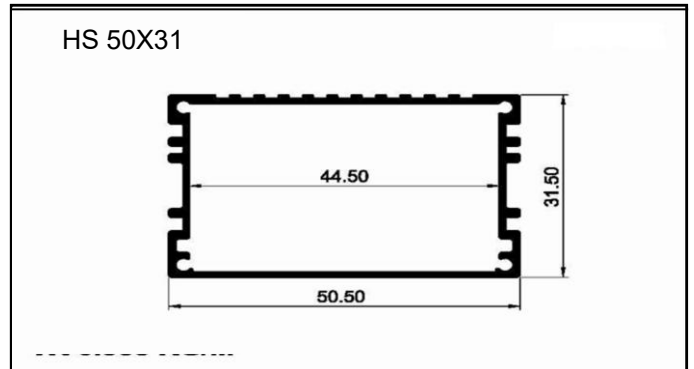
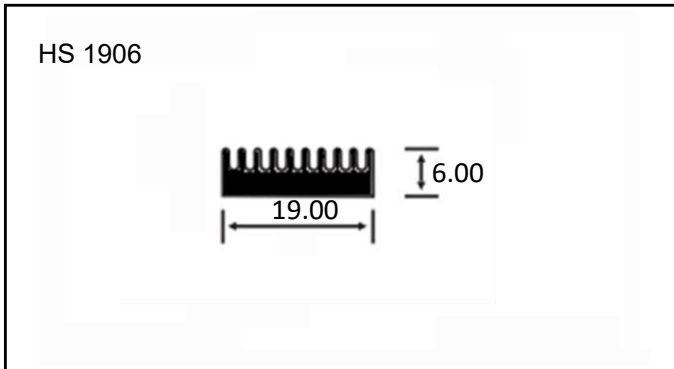
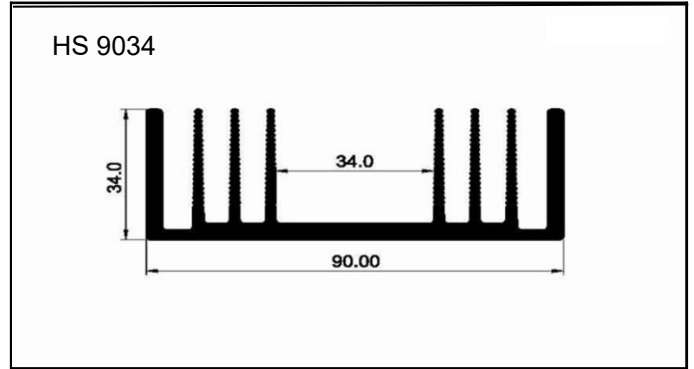
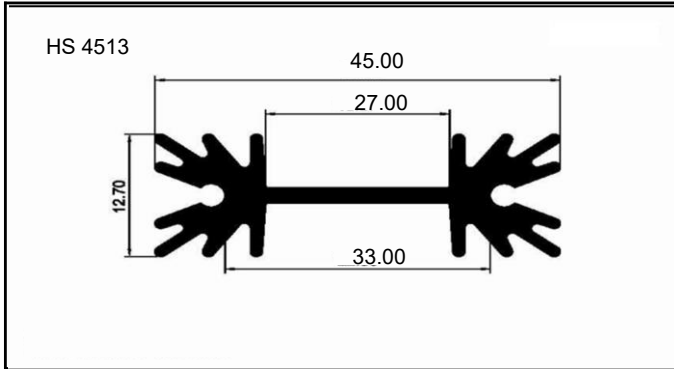
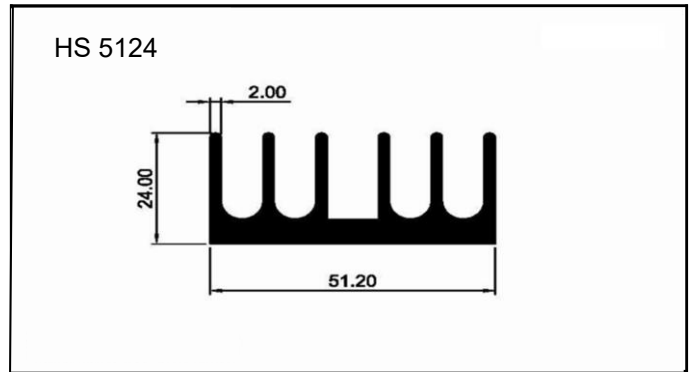
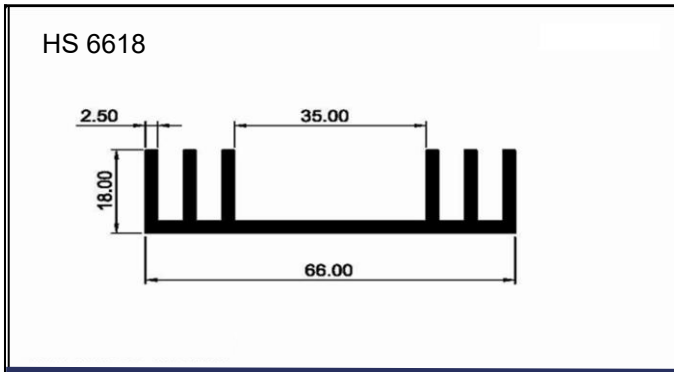

NIMBLES HEATSINKS

HS 7771

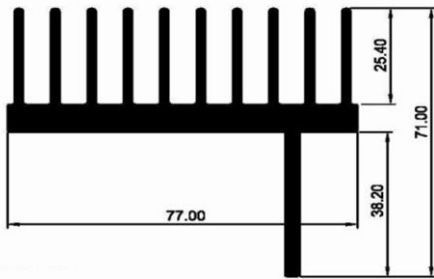

HS 7222



HS 8832

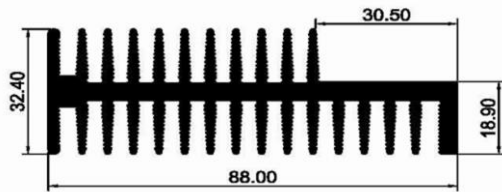

HS 5734

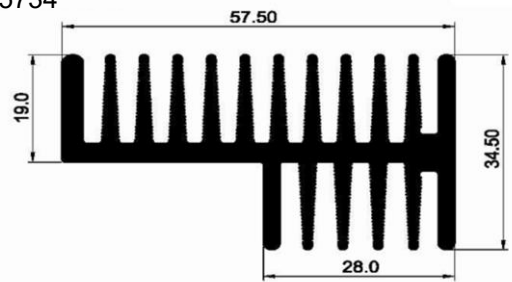

HS 8723

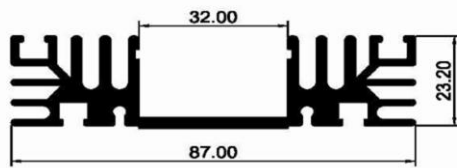

HS 13432

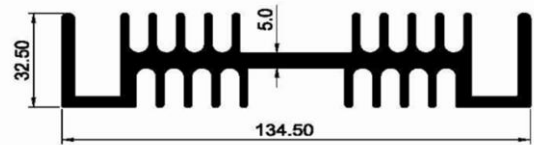

HS 9144

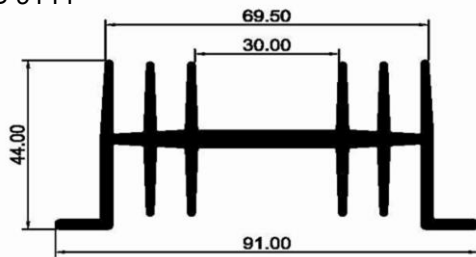

HS 9230

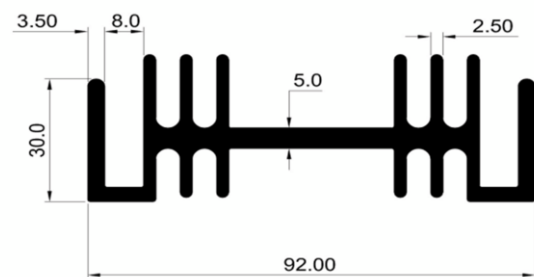

HS D16

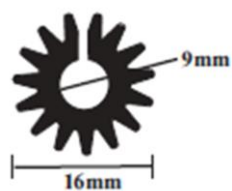

HS 5014

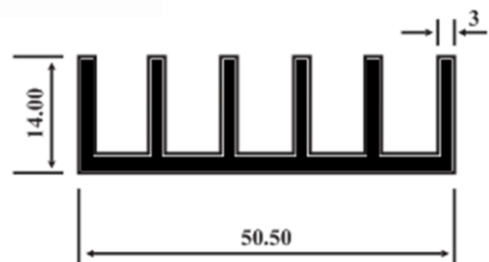

NIMBLES HEATSINKS

